

SCOTCHLOK[®] 560 IDC Electrical Tap Connector

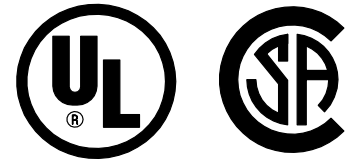

Application:

Use part No. 560 to electrically connect a (tap) wire end to a through (run) wire and insulate the connection.

Wire Range:

18–16 AWG(0,75–1,0mm²) solid or stranded, 14AWG (1,5mm²) stranded, tinned or untinned copper conductors.
For use with thermoplastic insulated wire such as; T, TW, TFF, TFN, TFFN, AWN, TEW, SAE–GPT with a maximum insulation diameter of .145 inches (3.5mm). Maximum recommended current for general purpose application: 18 AWG–7 AMPS, 16 AWG–10 AMPS, 14 AWG–15 AMPS.

Construction:

U–Contact – Tin plated brass
.03 inches (0.8mm) thick
Insulator – Flame retardant polypropylene,
Color – light blue

Weight:

.0032 lb. (1.45gm)

Engineering Specification:

Insulation Displacement Connector (as manufactured by 3M, part No. 560) capable of connecting a tap wire to a run wire, in the range of No.18–16 AWG(0,75–1,0mm²) solid or stranded, 14AWG (1,5mm²) stranded, tinned or untinned copper conductors. The connector shall be UL Listed and CSA Certified for 600 Volts maximum building wire: 1000 Volts maximum, signs fixtures and luminaires, and have a maximum insulating temperature of 105°C, (221°F).

Installation Instructions:

CAUTION – turn power off before installing connector. All electrical work should be done according to appropriate electrical codes.

1. Place unstripped run wire inside run channel.
2. Insert unstripped tap wire completely.
3. Hold tool perpendicular to the wire and make the connection by crimping the u–contact down flush with the top of the plastic insulator.
4. Close hinged top cover until latched.

Recommended Installation Tool:

3M No. E–9BM Crimping Tool
9” Linemans Pliers

Regulatory Agencies:

U.L. Listed – Tested per UL Standard 486C
U.L. File No. E23438

C.S.A. Certified – CSA Stranded C22.2 No. 188–M1983
CSA File No. LR15503, LR32411







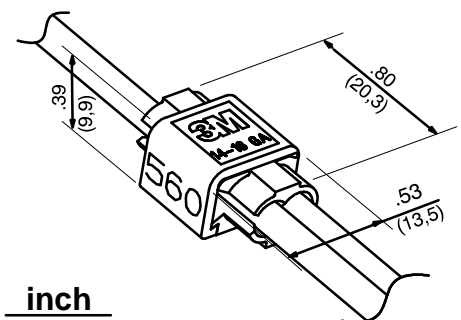
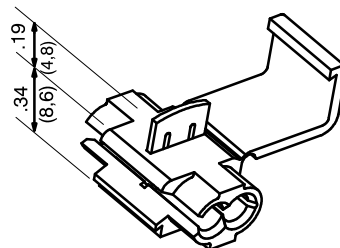
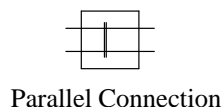
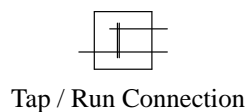







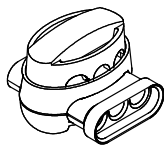
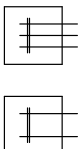

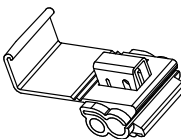



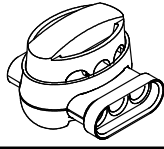
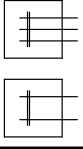

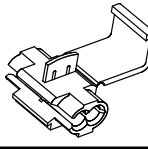
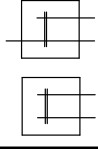
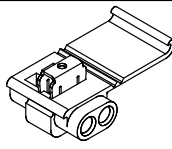



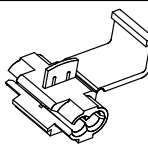

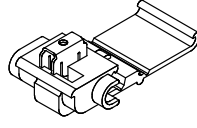



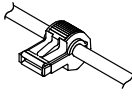



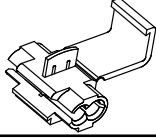
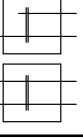

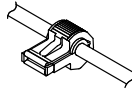



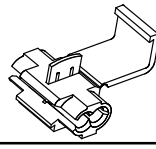
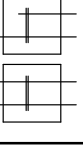

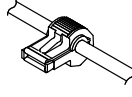

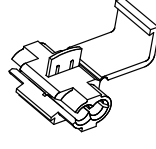

Federal Specification W–S–610
Commercial Packing Only

Type	Class	Kind	Style
II	I	cu	F

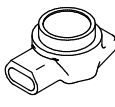
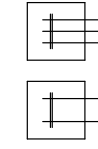
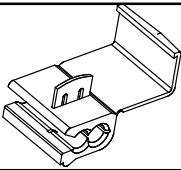
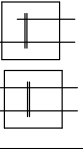
(Voltage rated at 600 volts maximum building wire: 1000 volts maximum, signs, fixtures and luminaires. Insulation temperature: 105°C (221°F). **Note:** Listed and Certified for AWG wire only.

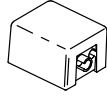

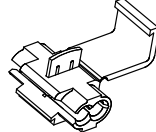
inch
(mm)

	Part # Wire Range	Type of Connector	 Listed	 Certified		Part # Wire Range	Type of Connector	 Listed	 Certified
	314 22-14					567 12-10run 18-14tap			
	314 22-14					905 18-14run 22-18Tap			
	557 22-16					905N 18-14run 22-18Tap			
	558 22-16					951 22-18			
	560 18-14					952 18-14			
	560B 18-14					953 12			
	560N 18-14					UR 19-26 Solid			
	562 12-10					UB 22-26 Solid			
	564 18-14				NOTE: For complete wire combinations or other technical information see individual product information sheets or contact Technical Service.				

IMPORTANT NOTICE TO PURCHASER:
All statements, technical information and recommendations related to the Seller's products are based on information believed to be reliable, but the accuracy or completeness thereof is not guaranteed. Before utilizing the product, the user should determine the suitability of the product for its intended use. The user assumes all risks and liability whatsoever in connection with such use.

All statements or recommendations of the seller which are not contained in the Seller's current publications shall have no force or effect unless contained in an agreement signed by an authorized officer of the Seller. The statements contained herein are made in lieu of all warranties express or implied, including but not limited to the implied warranties of merchantability and fitness for a particular purpose which warranties are hereby expressly disclaimed.

SELLER SHALL NOT BE LIABLE TO THE USER OR ANY OTHER PERSON UNDER ANY LEGAL THEORY, INCLUDING BUT NOT LIMITED TO NEGLIGENCE OR STRICT LIABILITY, FOR ANY INJURY OR FOR ANY DIRECT OR CONSEQUENTIAL DAMAGES SUSTAINED OR INCURRED BY REASON OF THE USE OF ANY OF THE SELLER'S PRODUCTS.

© 3M 1991

7 / 9 / 91

3M Electrical Products Division

6801 River Place Blvd.
Austin, Texas 78726-4599

